

DO NOT OPEN THIS TEST BOOKLET UNTIL YOU ARE ASKED TO DO SO

T.B.C. : MKA-S-EEN

Test Booklet Series

Serial

1074853

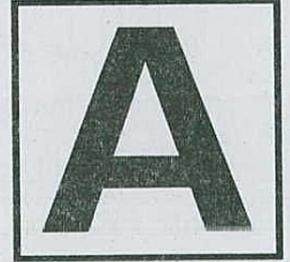

TEST BOOKLET

ELECTRICAL ENGINEERING

Time Allowed : Three Hours

Maximum Marks : 300

INSTRUCTIONS

1. IMMEDIATELY AFTER THE COMMENCEMENT OF THE EXAMINATION, YOU SHOULD CHECK THAT THIS TEST BOOKLET **DOES NOT** HAVE ANY UNPRINTED OR TORN OR MISSING PAGES OR ITEMS, ETC. IF SO, GET IT REPLACED BY A COMPLETE TEST BOOKLET.
2. Please note that it is the candidate's responsibility to encode and fill in the Roll Number and Test Booklet Series Code A, B, C or D carefully and without any omission or discrepancy at the appropriate places in the OMR Answer Sheet. Any omission/discrepancy will render the Answer Sheet liable for rejection.
3. You have to enter your Roll Number on the Test Booklet in the Box provided alongside.  
**DO NOT** write *anything else* on the Test Booklet.
4. This Test Booklet contains 150 items (questions). Each item comprises four responses (answers). You will select the response which you want to mark on the Answer Sheet. In case, you feel that there is more than one correct response, mark the response which you consider the best. In any case, choose **ONLY ONE** response for each item.
5. You have to mark your responses **ONLY** on the separate Answer Sheet provided. See directions in the Answer Sheet.
6. All items carry equal marks.
7. Before you proceed to mark in the Answer Sheet the response to various items in the Test Booklet, you have to fill in some particulars in the Answer Sheet as per instructions sent to you with your Admission Certificate.
8. After you have completed filling in all your responses on the Answer Sheet and the examination has concluded, you should hand over to the Invigilator **only the Answer Sheet**. You are permitted to take away with you the Test Booklet.
9. Sheets for rough work are appended in the Test Booklet at the end.
10. **Penalty for wrong answers :**  
**THERE WILL BE PENALTY FOR WRONG ANSWERS MARKED BY A CANDIDATE.**
  - (i) There are four alternatives for the answer to every question. For each question for which a wrong answer has been given by the candidate, **one-third (0.33)** of the marks assigned to that question will be deducted as penalty.
  - (ii) If a candidate gives more than one answer, it will be treated as a **wrong answer** even if one of the given answers happens to be correct and there will be same penalty as above to that question.
  - (iii) If a question is left blank, i.e., no answer is given by the candidate, there will be **no penalty** for that question.

DO NOT OPEN THIS TEST BOOKLET UNTIL YOU ARE ASKED TO DO SO

1. If a square matrix of order 100 has exactly 15 distinct eigenvalues, then the degree of the minimal polynomial is

- (a) At least 15
- (b) At most 15
- (c) Always 15
- (d) Exactly 100

2. The solution of the differential equation

$$y\sqrt{1-x^2} dy + x\sqrt{1-y^2} dx = 0$$

- (a)  $\sqrt{1-x^2} = c$
- (b)  $\sqrt{1-y^2} = c$
- (c)  $\sqrt{1-x^2} + \sqrt{1-y^2} = c$
- (d)  $\sqrt{1+x^2} + \sqrt{1+y^2} = c$

3. The general solution of the differential equation

$$\frac{d^4y}{dx^4} - 2\frac{d^3y}{dx^3} + 2\frac{d^2y}{dx^2} - 2\frac{dy}{dx} + y = 0$$

- (a)  $y = (c_1 - c_2x)e^x + c_3 \cos x + c_4 \sin x$
- (b)  $y = (c_1 + c_2x)e^x - c_3 \cos x + c_4 \sin x$
- (c)  $y = (c_1 + c_2x)e^x + c_3 \cos x + c_4 \sin x$
- (d)  $y = (c_1 + c_2x)e^x + c_3 \cos x - c_4 \sin x$

4. Given the Fourier series in  $(-\pi, \pi)$  for  $f(x) = x \cos x$ , the value of  $a_0$  will be

- (a)  $-\frac{2}{3}\pi^2$
- (b) 0
- (c) 2
- (d)  $\frac{(-1)^n 2n}{n^2 - 1}$

5. The Fourier series expansion of the saw-toothed waveform

$$f(x) = x \text{ in } (-\pi, \pi) \text{ of period } 2\pi \text{ gives the series, } 1 - \frac{1}{3} + \frac{1}{5} - \frac{1}{7} + \dots$$

The sum is equal to

- (a)  $\frac{\pi}{2}$
- (b)  $\frac{\pi^2}{4}$
- (c)  $\frac{\pi^2}{16}$
- (d)  $\frac{\pi}{4}$

6. What is the value of  $m$  for which  $2x - x^2 + my^2$  is harmonic?

- (a) 1
- (b) -1
- (c) 2
- (d) -2

7. Evaluate

$$\int_c \frac{dz}{z \sin z}, \text{ where } c \text{ is } x^2 + y^2 = 1.$$

- (a) 1
- (b) 2
- (c) 0
- (d) -1

8. The sum of residues of  $f(z) = \frac{2z}{(z-1)^2(z-2)}$

at its singular point is

- (a) -8
- (b) -4
- (c) 0
- (d) 4

9. A bag contains 7 red and 4 white balls. Two balls are drawn at random. What is the probability that both the balls are red ?
- (a)  $\frac{28}{55}$   
 (b)  $\frac{21}{55}$   
 (c)  $\frac{7}{55}$   
 (d)  $\frac{4}{55}$
10. A random variable X has the density function  $f(x) = K \frac{1}{1+x^2}$ , where  $-\infty < x < \infty$ . Then the value of K is
- (a)  $\pi$   
 (b)  $\frac{1}{\pi}$   
 (c)  $2\pi$   
 (d)  $\frac{1}{2\pi}$
11. A random variable X has a probability density function
- $$f(x) = \begin{cases} k x^n e^{-x}; & x \geq 0 \\ 0; & \text{otherwise} \end{cases} \quad (n \text{ is an integer})$$
- with mean 3. The values of {k, n} are
- (a)  $\left\{\frac{1}{2}, 1\right\}$   
 (b)  $\left\{\frac{1}{4}, 2\right\}$   
 (c)  $\left\{\frac{1}{2}, 2\right\}$   
 (d) {1, 2}
12. What is the probability that at most 5 defective fuses will be found in a box of 200 fuses, if 2% of such fuses are defective ?
- (a) 0.82  
 (b) 0.79  
 (c) 0.59  
 (d) 0.52
13. If X is a normal variate with mean 30 and standard deviation 5, what is Probability  $(26 \leq X \leq 34)$ , given  $A(z = 0.8) = 0.2881$  ?
- (a) 0.2881  
 (b) 0.5762  
 (c) 0.8181  
 (d) 0.1616
14. For high speed reading and storing of information in a computer, the core shall be of
- (a) Ferrite  
 (b) Piezoelectric  
 (c) Pyroelectric  
 (d) Ferromagnetic above 768°C
15. Soft magnetic materials should have
- (a) Large saturation magnetization and large permeability  
 (b) Low saturation magnetization and large permeability  
 (c) Large saturation magnetization and low permeability  
 (d) Low saturation magnetization and low permeability
16. Gauss's theorem states that total electric flux  $\Phi$  emanating from a closed surface is equal to
- (a) Total current density on the surface  
 (b) Total charge enclosed by that surface  
 (c) Total current on the surface  
 (d) Total charge density within the surface
17. Orbital magnetic moment of an electron, in an atom, is of the order of
- (a) 0.1 Bohr magneton  
 (b) 1.0 Bohr magneton  
 (c) 10 Bohr magneton  
 (d) 100 Bohr magneton

18. When the temperature of a ferromagnetic material exceeds the Curie temperature, it behaves similar to a
- Diamagnetic material
  - Ferrimagnetic material
  - Paramagnetic material
  - Antiferromagnetic material
19. Photoconductivity is a characteristic of semiconductors. When light falls on certain semiconductors, it
- Sets free electrons from some of the atoms, increasing the conductivity
  - Ejects electrons into space
  - Establishes a potential difference creating a source of EMF
  - Produces heat raising the temperature
20. The resistivity of intrinsic germanium at 30°C is 0.46  $\Omega$ -m. What is the intrinsic carrier density  $n_i$  at 30°C, taking the electron mobility  $\mu_n$  as 0.38  $m^2/V$ -s and hole mobility  $\mu_p$  as 0.18  $m^2/V$ -s?
- $2.4 \times 10^{19}/m^3$
  - $4.2 \times 10^{19}/m^3$
  - $2.4 \times 10^{10}/m^3$
  - $4.2 \times 10^{10}/m^3$
21. For intrinsic gallium arsenide, conductivity at room temperature is  $10^{-6} (\Omega\text{-m})^{-1}$ , the electron and hole mobilities are, respectively 0.85 and 0.04  $m^2/V$ -s. The intrinsic carrier concentration  $n$  at room temperature is
- $7.0 \times 10^{12} m^{-3}$
  - $0.7 \times 10^{12} m^{-3}$
  - $7.0 \times 10^{-12} m^{-3}$
  - $0.7 \times 10^{-12} m^{-3}$
22. A copper conductor has a resistance of 15.5  $\Omega$  at 0°C. What is its percentage conductivity at 16°C (to nearest unit value) assuming the temperature coefficient of copper as 0.00428 per °C at 0°C?
- 54%
  - 68%
  - 94%
  - 98%
23. At temperatures above a limiting value, the energy of lattice vibrations, in a conductor, increases linearly with temperature so that resistivity increases linearly with temperature. In this region, this limiting value of temperature is called
- Bernoulli temperature
  - Curie temperature
  - Debye temperature
  - Neel temperature
24. Consider the following statements :
- The critical magnetic field of a superconductor is maximum at absolute zero.
  - Transition temperature of a superconductor is sensitive to its structure.
  - The critical magnetic field of a superconductor is zero at its critical temperature.
  - Superconductors show very high conductivity below the critical temperature.
- Which of the above statements are correct ?
- 1, 2 and 3 only
  - 1, 2 and 4 only
  - 2, 3 and 4 only
  - 1, 3 and 4 only

25. What is the correct sequence of the following materials in ascending order of their resistivity ?

1. Iron
2. Silver
3. Constantan
4. Mica
5. Aluminium

Select the correct answer using the codes given below :

- (a) 2, 5, 1, 3 and 4
- (b) 4, 5, 3, 1 and 2
- (c) 2, 3, 1, 5 and 4
- (d) 4, 5, 1, 3 and 2

26. In the first Cauer network, with a pole at infinity, the first element must be

- (a) Series capacitor
- (b) Series inductor
- (c) Shunt capacitor
- (d) Shunt inductor

27. The total magnetic moment

1. is called saturation magnetization.
2. depends on the number of magnetic dipoles per unit volume, the instant electric current and the area of the current loop.

Which of the above statements is/are correct ?

- (a) 1 only
- (b) 2 only
- (c) Both 1 and 2
- (d) Neither 1 nor 2

28. Which of the following statements are correct regarding dot product of vectors ?

1. Dot product is less than or equal to the product of magnitudes of two vectors.
2. When two vectors are perpendicular to each other, then their dot product is non-zero.
3. Dot product of two vectors is positive or negative depending whether the angle between the vectors is less than or greater than  $\frac{\pi}{2}$ .
4. Dot product is equal to the product of one vector and the projection of the vector on the first one.

Select the correct answer using the codes given below :

- (a) 1, 2 and 3 only
- (b) 1, 3 and 4 only
- (c) 1, 2 and 4 only
- (d) 2, 3 and 4 only

29. Susceptibility of a diamagnetic material is

1. Negative
2. Positive
3. Dependent on the temperature
4. Independent of the temperature

Select the correct answer using the codes given below :

- (a) 1 and 3 only
- (b) 2 and 3 only
- (c) 1 and 4 only
- (d) 2 and 4 only

30. Consider the following statements :

1. The susceptibility  $\chi$  of diamagnetic materials is small and negative.
2. The susceptibility of para and anti ferromagnetic materials is small but positive.
3. The susceptibility has a finite value for free space or air.

Which of the above statements are correct ?

- (a) 1 and 2 only
- (b) 1 and 3 only
- (c) 2 and 3 only
- (d) 1, 2 and 3

- 31.** Eddy current losses in transformer cores can be reduced by the use of
1. Solid cores
  2. Laminated cores
  3. Ferrites
- Select the correct answer using the codes given below :
- (a) 2 and 3 only
  - (b) 1 and 2 only
  - (c) 1 and 3 only
  - (d) 1, 2 and 3
- 32.** The phenomenon of magnetostriction occurs when a ferromagnetic substance is magnetized resulting in
- (a) Heating
  - (b) Small changes in its dimensions
  - (c) Small changes in its crystal structure
  - (d) Some change in its mechanical properties
- 33.** What type of defect causes F-centers in a crystal ?
- (a) Stoichiometric defect
  - (b) Metal excess defect due to anion vacancies
  - (c) Metal excess defect due to extra cations
  - (d) Frenkel defect
- 34.** Consider the following statements :
1. Superconductors exhibit normal conductivity behaviour above a transition temperature  $T_c$ .
  2. Superconductors lose their superconducting nature in an external magnetic field, provided the external magnetic field is above a critical value.
  3. High  $T_c$  superconductors have  $T_c$  values in the range 1 to 10 K.
- Which of the above statements are correct ?
- (a) 1 and 2 only
  - (b) 1 and 3 only
  - (c) 2 and 3 only
  - (d) 1, 2 and 3
- 35.** Superconductivity is a material property associated with
- (a) Changing shape by stretching
  - (b) Stretching without breaking
  - (c) A loss of thermal resistance
  - (d) A loss of electrical resistance
- 36.** An atom in a crystal vibrates at a frequency, determined by
1. Crystal heat current
  2. Crystal temperature
  3. The stiffness of the bonds with neighbour atoms
- Select the correct answer using the codes given below :
- (a) 1 only
  - (b) 2 only
  - (c) 3 only
  - (d) 1, 2 and 3
- 37.** Consider the following statements :
1. Nano means  $10^{-9}$  so that nano materials have an order of dimension higher than the size of atom and come in the form of rods, tubes, spheres or even thin sheets/films.
  2. Nano materials have enhanced or changed structural property.
  3. Nano elements lend themselves to mechanical processing like rolling, twisting, positioning.
  4. Nano elements show important electrical, magnetic and optical characteristics that are useful in electrical industry.
- Which of the above statements are correct ?
- (a) 1, 2 and 3 only
  - (b) 1, 2, 3 and 4
  - (c) 3 and 4 only
  - (d) 1, 2 and 4 only

38. The voltage and current waveforms for an element are shown in the figure.

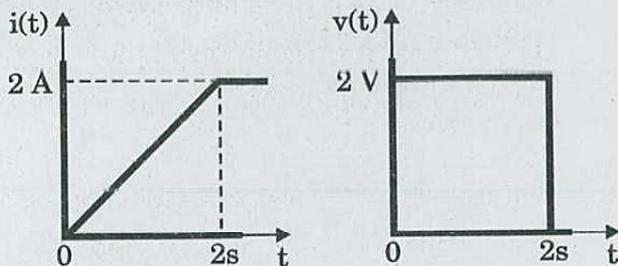

The circuit element and its value are

- (a) Capacitor, 2 F  
 (b) Inductor, 2 H  
 (c) Capacitor, 0.5 F  
 (d) Inductor, 0.5 H
39. In a connected graph, the total number of branches is  $b$  and the total number of nodes is  $n$ . Then the number of links  $L$  of a co-tree is

- (a)  $b - n$   
 (b)  $b - n - 1$   
 (c)  $b + n - 1$   
 (d)  $b - n + 1$

40. For the circuit shown, Thevenin's open circuit voltage  $V_{oc}$  and Thevenin's equivalent resistance  $R_{eq}$  at terminals A-B are, respectively,

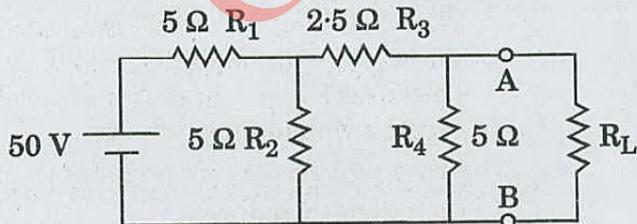

- (a) 6.25 V and 2.5 Ω  
 (b) 12.5 V and 5 Ω  
 (c) 6.25 V and 5 Ω  
 (d) 12.5 V and 2.5 Ω

41. What is the current through the 8 Ω resistance connected across terminals, M and N in the circuit?

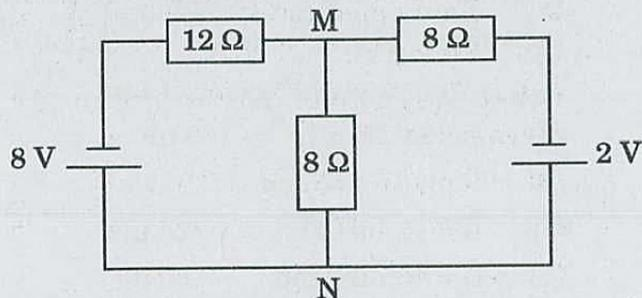

- (a) 0.34 A from M to N  
 (b) 0.29 A from M to N  
 (c) 0.29 A from N to M  
 (d) 0.34 A from N to M

42. What is the value of resistance  $R$  which will allow maximum power dissipation in the circuit?

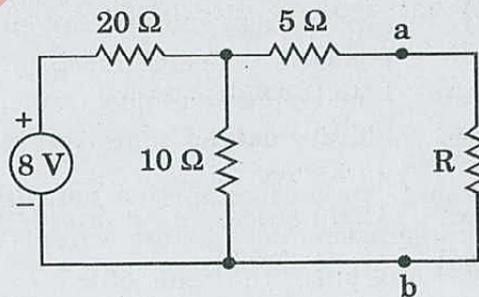

- (a) 11.66 Ω  
 (b) 10.33 Ω  
 (c) 8.33 Ω  
 (d) 7.66 Ω

43. Two resistors of 5 Ω and 10 Ω and an inductor  $L$  are connected in series across a  $50 \cos \omega t$  voltage source. If the power consumed by the 5 Ω resistor is 10 W, the power factor of the circuit is

- (a) 1.0  
 (b) 0.8  
 (c) 0.6  
 (d) 0.4

44. A two-element series circuit is connected across an AC source given by  $e = 200\sqrt{2} \sin(314t + 20) \text{ V}$ . The current is then found to be  $i = 10\sqrt{2} \cos(314t - 25) \text{ A}$ . The parameters of the circuit are

- (a)  $R = 20 \Omega$  and  $C = 160 \mu\text{F}$
- (b)  $R = 14.14 \Omega$  and  $C = 225 \mu\text{F}$
- (c)  $L = 45 \text{ mH}$  and  $C = 225 \mu\text{F}$
- (d)  $L = 45 \text{ mH}$  and  $C = 160 \mu\text{F}$

45. How fast can the output of an OP Amp change by 10 V, if its slew rate is 1 V/ $\mu\text{s}$ ?

- (a) 5  $\mu\text{s}$
- (b) 10  $\mu\text{s}$
- (c) 15  $\mu\text{s}$
- (d) 20  $\mu\text{s}$

46. A three-phase star-connected load is operating at a power factor angle  $\Phi$ , with  $\Phi$  being the angle between

- (a) Line voltage and line current
- (b) Phase voltage and phase current
- (c) Line voltage and phase current
- (d) Phase voltage and line current

47. For a two-port reciprocal network, the three transmission parameters are  $A = 4$ ,  $B = 7$  and  $C = 5$ . What is the value of  $D$ ?

- (a) 9.5
- (b) 9.0
- (c) 8.5
- (d) 8.0

48. Consider the following as representations of reciprocity in terms of z-parameters :

1.  $z_{11} = z_{12}$
2.  $z_{12} = z_{22}$
3.  $z_{12} = z_{21}$

Which of the above representations is/are correct?

- (a) 1 only
- (b) 2 only
- (c) 3 only
- (d) 1, 2 and 3

49. A parallel-plate capacitor is made of two circular plates separated by a distance of 5 mm and with a dielectric with dielectric constant of 2.2 between them. When the electric field in the dielectric is  $3 \times 10^4 \text{ V/m}$ , the charge density of the positive plate will be, nearly

- (a)  $58.5 \times 10^4 \text{ C/m}^2$
- (b)  $29.5 \times 10^4 \text{ C/m}^2$
- (c)  $29.5 \times 10^{-4} \text{ C/m}^2$
- (d)  $58.5 \times 10^{-4} \text{ C/m}^2$

50. What is the potential drop across the 80  $\Omega$  resistor in the figure?

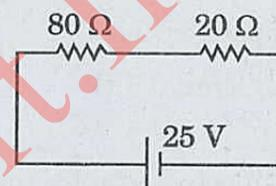

- (a) 20 V
- (b) 15 V
- (c) 10 V
- (d) 5 V

51. When 7/0-029 V.I.R cable is carrying 20 A, a drop of 1 V occurs every 12 m. The voltage drop in a 100 m run of this cable when it is carrying 10 A is nearly

- (a) 4.2 V
- (b) 3.2 V
- (c) 1.2 V
- (d) 0.42 V

52. Consider the following statements :

If a high Q parallel resonant circuit is loaded with a resistance

1. The circuit impedance reduces.
2. The resonant frequency remains the same.
3. The bandwidth reduces.

Which of the above statements is/are correct?

- (a) 3 only
- (b) 2 only
- (c) 1 only
- (d) 1, 2 and 3

53. A drawn wire of resistance  $5 \Omega$  is further drawn so that its diameter becomes one-fifth of the original. What is its resistance with volume remaining the same ?

- (a)  $25 \Omega$
- (b)  $125 \Omega$
- (c)  $625 \Omega$
- (d)  $3125 \Omega$

54. The three non-inductive loads of 5 kW, 3 kW and 2 kW are connected in a star network between R, Y and B phases and neutral. The line voltage is 400 V. The current in the neutral wire is nearly

- (a) 11 A
- (b) 14 A
- (c) 17 A
- (d) 21 A

55. Kirchhoff's current law is applicable to

1. Closed loops in a circuit
2. Junction in a circuit
3. Magnetic circuits

Which of the above is/are correct ?

- (a) 1 only
- (b) 2 only
- (c) 3 only
- (d) 1, 2 and 3

56. Which of the following are satisfied in a non-linear network ?

1. Associative
2. Superposition
3. Homogeneity
4. Bilaterality

Select the correct answer using the codes given below :

- (a) 1 and 3 only
- (b) 1 and 4 only
- (c) 2 and 3 only
- (d) 2 and 4 only

57.  $\nabla \times \vec{H} = \sigma \vec{E} + \epsilon \left( \frac{\partial \vec{E}}{\partial t} \right)$  is

- (a) Modified Faraday's law
- (b) Gauss's law
- (c) Biot-Savart law
- (d) Modified Ampere's law

58. Consider the following statements :

1. Network theorems are not derivable from Kirchhoff's law.
2. To get the Norton current, one has to short the current source.
3. Thevenin's theorem is suitable for a circuit involving voltage sources and series connections.

Which of the above statements is/are correct ?

- (a) 1, 2 and 3
- (b) 1 only
- (c) 2 only
- (d) 3 only

59. What are the Thevenin's equivalent voltage  $V_{TH}$  and resistance  $R_{TH}$  between the terminals A and B of the circuit ?

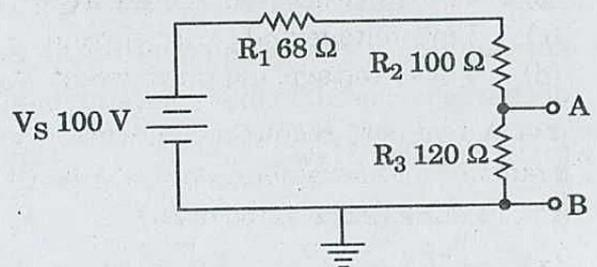

- (a) 4.16 V and  $120 \Omega$
- (b) 41.67 V and  $120 \Omega$
- (c) 4.16 V and  $70 \Omega$
- (d) 41.67 V and  $70 \Omega$

60. What is the current through the  $5 \Omega$  resistance in the circuit shown ?

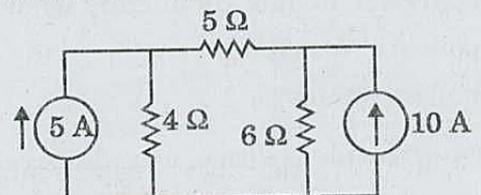

- (a) 5.33 A
- (b) 4.66 A
- (c) 2.66 A
- (d) 1.33 A

61. Consider the following statements with regard to Lissajous pattern on a CRO :

1. It is a stationary pattern on the CRO.
2. It is used for precise measurement of frequency of a voltage signal.
3. The ratio between frequencies of vertical and longitudinal voltage signals should be an integer to have a steady Lissajous pattern.

Which of the above statements is/are correct ?

- (a) 1 only
- (b) 2 only
- (c) 3 only
- (d) 1, 2 and 3

62. "Electric flux enclosed by a surface surrounding a charge is equal to the amount of charge enclosed." This is the statement of

- (a) Faraday's law
- (b) Lenz's law
- (c) Modified Ampere's law
- (d) Gauss's law

63. If a positively charged body is placed inside a spherical hollow conductor, what will be the polarity of charge inside and outside the hollow conductor ?

- (a) Inside positive, outside negative
- (b) Inside negative, outside positive
- (c) Both negative
- (d) Both positive

64. Consider the following statements regarding Peer-to-Peer computing environment :

1. In this system, clients and servers are not distinguished from one another.
2. All nodes distributed throughout the system (within) are considered Peers and each may act as either a client or a server.
3. Peer-to-Peer system assuredly offers certain advantages over the traditional client-server system.
4. Peer-to-Peer system is just a replica of the file-server system.

Which of the above statements are correct ?

- (a) 1, 2, 3 and 4
- (b) 1, 2 and 3 only
- (c) 1 and 4 only
- (d) 2, 3 and 4 only

65. What is the octal equivalent of  $(5621 \cdot 125)_{10}$  ?

- (a) 11774·010
- (b) 12765·100
- (c) 16572·100
- (d) 17652·010

66. What is the hexadecimal representation of  $(657)_8$  ?

- (a) 1 AF
- (b) D 78
- (c) D 71
- (d) 32 F

67. In potential transformers, the secondary turns are increased slightly and the primary and secondary windings are wound as closely as possible to compensate for

- (a) Phase angle and ratio error, respectively
- (b) Ratio and phase angle error, respectively
- (c) Any eddy current loss and hysteresis loss, respectively
- (d) The hysteresis loss and eddy current loss, respectively

68. The y-parameters for the network shown in the figure can be represented by

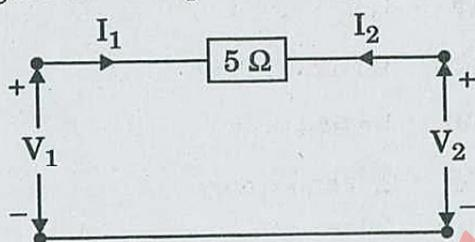

(a)  $[y] = \begin{bmatrix} -\frac{1}{5} & \frac{1}{5} \\ \frac{1}{5} & -\frac{1}{5} \end{bmatrix} \text{ } \mathcal{U}$

(b)  $[y] = \begin{bmatrix} \frac{1}{5} & -\frac{1}{5} \\ -\frac{1}{5} & \frac{1}{5} \end{bmatrix} \text{ } \mathcal{U}$

(c)  $[y] = \begin{bmatrix} -5 & 5 \\ 5 & -5 \end{bmatrix} \text{ } \mathcal{U}$

(d)  $[y] = \begin{bmatrix} 5 & -5 \\ -5 & 5 \end{bmatrix} \text{ } \mathcal{U}$

69. In the two-port network shown, which of the following is correct?

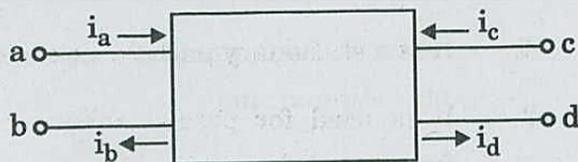

- (a)  $i_b = i_c$
- (b)  $i_a = i_d$
- (c)  $i_c = i_d$
- (d)  $i_a = i_b$

70. A  $4\frac{1}{2}$  digit voltmeter is used for voltage measurement. How would 0.7525 V be displayed in 1 V range?

- (a) 0.7525 V
- (b) 0.752 V
- (c) 0.075 V
- (d) 0.0752 V

71. Which of the following equations represent Gauss's law adapted to a homogeneous isotropic medium?

1.  $\oint_s \vec{D} \cdot d\vec{s} = \oint_v \rho dv$

2.  $\nabla \times \vec{H} = \vec{D}$

3.  $\nabla \cdot \vec{J} + \rho = 0$

4.  $\nabla \cdot \vec{E} = \frac{\rho}{\epsilon}$

5.  $\nabla^2 \phi = 0$

Select the correct answer using the codes given below:

- (a) 1 and 4 only
- (b) 2 and 3 only
- (c) 3 and 5 only
- (d) 1, 2, 4 and 5 only

72. Consider the following statements with regard to Moving Iron (MI) instruments :

1. These instruments possess high operating torque.
2. These instruments can be used in ac and dc circuits.
3. Power consumption in these instruments is lower for low voltage range.

Which of the above statements are correct ?

- (a) 1 and 2 only
- (b) 1 and 3 only
- (c) 2 and 3 only
- (d) 1, 2 and 3

73. A current of  $(10 + 5 \sin \omega t + 3 \sin 2\omega t)$  is measured using a moving iron instrument. The reading would be

- (a) 08.82 A
- (b) 10.00 A
- (c) 10.82 A
- (d) 12.75 A

74. Which one of the following methods is used for the measurement of high resistances ?

- (a) Carey-Foster bridge method
- (b) Substitution method
- (c) Loss of charge method
- (d) Potentiometer method

75. Consider the following statements with regard to induction type wattmeter :

1. Can be used on both ac and dc systems.
2. Power consumption is relatively low.
3. It is accurate only at stated frequency and temperature.

Which of the above statements is/are correct ?

- (a) 1 only
- (b) 2 only
- (c) 3 only
- (d) 1, 2 and 3

76. A computer system has a cache with a cache access time  $T_C = 10$  ns, a hit ratio of 80% and an average memory access time  $T_M = 20$  ns. What is the access time for physical memory  $T_P$  ?

- (a) 90 ns
- (b) 80 ns
- (c) 60 ns
- (d) 20 ns

77. If n has the value 3, then the C language statement :  $a[+ + n] = n + +;$  assigns

- (a) 3 to  $a[5]$
- (b) 4 to  $a[5]$
- (c) 4 to  $a[4]$
- (d) 5 to  $a[5]$

78. The minimum number of arithmetic operations required to evaluate the polynomial  $P(X) = X^5 + 8X^3 + X$  for a given value of X using only one temporary variable is

- (a) 8
- (b) 7
- (c) 6
- (d) 5

79. A freewheeling diode in phase-controlled rectifiers

- enables inverter operation
- is responsible for additional reactive power
- improves the line power factor
- is responsible for additional harmonics

80. Consider the following statements regarding electrical conductivity  $\sigma$  :

- It increases with temperature in semiconductors.
- Its increase with temperature is exponential.
- It increases in metals and their alloys, linearly with temperature.

Which of the above statements are correct ?

- 1 and 2 only
- 1 and 3 only
- 2 and 3 only
- 1, 2 and 3

81. What is the effect on the natural frequency ( $\omega_n$ ) and damping factor ( $\delta$ ) in the control systems when derivative compensation is used ?

- $\omega_n$  increases and  $\delta$  decreases
- $\omega_n$  remains unchanged and  $\delta$  increases
- $\omega_n$  remains unchanged and  $\delta$  decreases
- $\omega_n$  decreases and  $\delta$  increases

82. Consider the following components in a multi-stage R-C coupled amplifier :

- Parasitic capacitance of transistor
- Coupling capacitance
- Stray capacitance
- Wiring capacitance

Which of the above components effectively control high frequencies ?

- 1, 2 and 3
- 1, 2 and 4
- 1, 3 and 4
- 2, 3 and 4

83. A Wien Bridge Oscillator is suitable for

- Audio frequency applications
- Radio frequency applications
- Very low frequency applications

Which of the above frequency applications is/are correct ?

- 1 only
- 2 only
- 3 only
- 1, 2 and 3

84. In an R-C phase shift oscillator using FET and 3-section R-C phase shift network, the condition for sustained oscillation is

- $\beta > 6n$
- $\beta > 29$
- $\beta > 4n + 23 + \frac{29}{n}$
- $\beta > 23 + \frac{29}{n}$

where,  $n = \frac{R_d}{R}$ .

85. A tuned-collector oscillator has a fixed inductance of  $100 \mu\text{H}$  and has to be tunable over the frequency band of  $500 \text{ kHz}$  to  $1500 \text{ kHz}$ . What is the range of variable capacitor to be used?

- (a)  $115 - 1021 \text{ pF}$
- (b)  $113 - 1015 \text{ pF}$
- (c)  $93 - 1015 \mu\text{F}$
- (d)  $110 - 1021 \mu\text{F}$

86. The logical expression,  $AB\bar{C} + A\bar{B}C + A\bar{B}\bar{C}$  is equivalent to

- (a)  $\bar{A}(B + C)$
- (b)  $\bar{A} + \bar{B} + \bar{C}$
- (c)  $\bar{A}\bar{B}\bar{C}$
- (d)  $A(\bar{C} + \bar{B})$

87. What is the analog output for a 4-bit R-2R ladder DAC when input is  $(1000)_2$ , for  $V_{\text{ref}} = 5 \text{ V}$ ?

- (a)  $2.3333 \text{ V}$
- (b)  $2.4444 \text{ V}$
- (c)  $2.5556 \text{ V}$
- (d)  $2.6667 \text{ V}$

88. Which logic inputs should be given to the input lines  $I_0, I_1, I_2$  and  $I_3$ , if the MUX is to behave as two input XNOR gate?

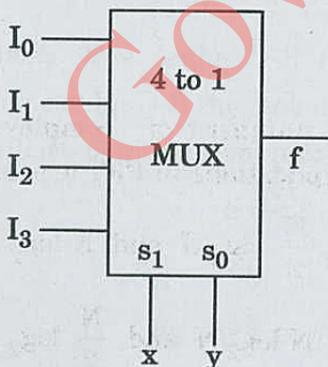

- (a) 0110
- (b) 1001
- (c) 1010
- (d) 1111

89. Fourier series of any periodic signal  $x(t)$  can be obtained if

$$1. \int_0^T |x(t)| dt < \infty$$

- 2. Finite number of discontinuities within finite time interval  $t$
- 3. Infinite number of discontinuities

Select the correct answer using the codes given below :

- (a) 1, 2 and 3
- (b) 1 and 3 only
- (c) 1 and 2 only
- (d) 2 and 3 only

90. Which one of the following statements is correct?

LTI system is causal

- (a) If and only if its impulse response is non-zero for negative values of  $n$ .
- (b) If and only if its impulse response is non-zero for positive values of  $n$ .
- (c) If its impulse response is zero for negative values of  $n$ .
- (d) If its impulse response is zero for positive values of  $n$ .

91. Consider the following statements with respect to Discrete Fourier Transform (DFT) :

1. It is obtained by performing a sampling operation in the time domain.
2. It transforms a finite duration sequence into a discrete frequency spectrum.
3. It is obtained by performing a sampling operation in both time and frequency domains.

Which of the above statements is/are correct ?

- (a) 1 and 2 only
- (b) 2 and 3 only
- (c) 1 only
- (d) 3 only

92. The Laplace transform of the below function is

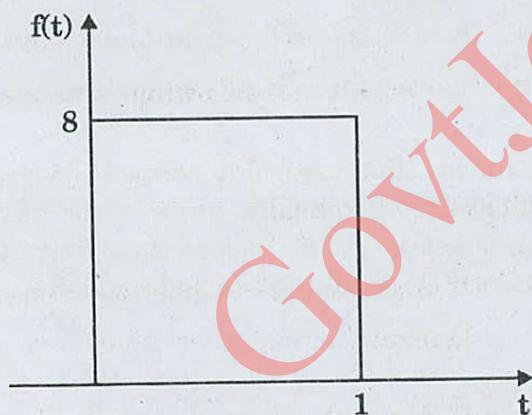

- (a)  $F(s) = 8s(1 - e^{-s})$
- (b)  $F(s) = \frac{8}{s}(1 + e^{-s})$
- (c)  $F(s) = 8s(1 + e^{-s})$
- (d)  $F(s) = \frac{8}{s}(1 - e^{-s})$

93. The number of complex additions and multiplications in direct DFT are, respectively

- (a)  $N(N - 1)$  and  $N^2$
- (b)  $N(N + 1)$  and  $N^2$
- (c)  $N(N + 1)^2$  and  $N$
- (d)  $N$  and  $N^2$

94. The Fourier transform of a unit rectangular pulse shown in the figure is

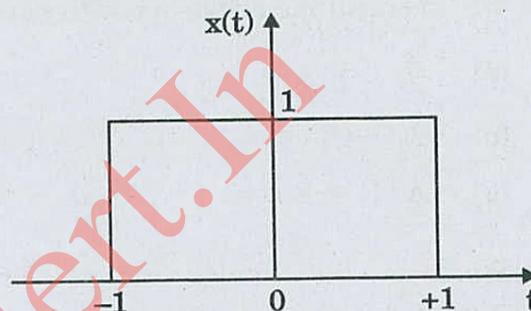

- (a)  $\omega \sin \omega$
- (b)  $\frac{2 \sin \omega}{\omega}$
- (c)  $\frac{\omega}{\sin \omega}$
- (d)  $\frac{\cos \omega}{2\omega}$

95. The number of complex additions and multiplications in FFT are, respectively,

- (a)  $\frac{N}{2} \log_2 N$  and  $N \log_2 N$
- (b)  $N \log_2 N$  and  $\frac{N}{2} \log_2 N$
- (c)  $\frac{N}{2} \log_2 N$  and  $\log_2 N$
- (d)  $\log_2 N$  and  $\frac{N}{2} \log_2 N$

96. Consider the following driving point impedance functions :

$$Z_1(s) = \frac{(s+2)}{(s^2+3s+5)}$$

$$Z_2(s) = \frac{(s+2)}{(s^2+5)}$$

$$Z_3(s) = \frac{(s+2)}{(s^2+2s+1)}$$

$$Z_4(s) = \frac{(s+2)(s+4)}{(s+1)(s+3)}$$

Which one of the above is positive real ?

- (a)  $Z_1$
- (b)  $Z_2$
- (c)  $Z_3$
- (d)  $Z_4$

97. The closed-loop transfer function of a system

$$\text{is } \frac{C(s)}{R(s)} = \frac{s-2}{s^3+8s^2+19s+12}$$

The system is

- (a) Stable
- (b) Unstable
- (c) Conditionally stable
- (d) Critically stable

98. A system has 14 poles and 2 zeros in its open-loop transfer function. The slope of its highest frequency asymptote in its magnitude plot is

- (a) -40 dB/dec
- (b) -240 dB/dec
- (c) +40 dB/dec
- (d) +240 dB/dec

99. The open-loop transfer function for the Bode's magnitude plot is

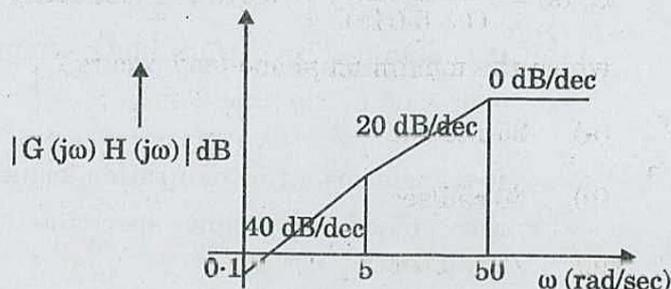

- (a)  $G(s)H(s) = \frac{K}{s^2(1+0.2s)(1+0.02s)}$
- (b)  $G(s)H(s) = \frac{Ks}{(1+0.2s)(1+0.02s)}$
- (c)  $G(s)H(s) = \frac{Ks^2}{(s+5)(s+50)}$
- (d)  $G(s)H(s) = \frac{K}{s^2(s+5)(s+50)}$

100. While forming a Routh array, the situation of a row of zeros indicates that the system

- (a) has symmetrically located roots
- (b) is stable
- (c) is insensitive to variations in gain
- (d) has asymmetrically located roots

101. A linear time-invariant control system with unsatisfactory steady state error is to be compensated. Which is/are the correct type of cascade compensation to be provided ?

1. Lead
2. Lag
3. Lag-lead

Select the correct answer using the codes given below :

- (a) 1 only
- (b) 2 only
- (c) 3 only
- (d) 1, 2 and 3

102. A phase-lead network has its transfer function  $G_C(s) = \frac{(1 + 0.04s)}{(1 + 0.01s)}$ . What is the frequency at which the maximum phase-lead occurs ?

- (a) 25 rad/sec
- (b) 50 rad/sec
- (c) 75 rad/sec
- (d) 100 rad/sec

103. What is the open-loop transfer function for the system, whose characteristic equation is  $F(s) = s^3 + 3s^2 + (K + 2)s + 5K = 0$  ?

- (a)  $G(s)H(s) = \frac{5K}{s(s+1)(s+3)}$
- (b)  $G(s)H(s) = \frac{Ks}{s(s+1)(s+2)}$
- (c)  $G(s)H(s) = \frac{K(s+5)}{s(s+1)(s+2)}$
- (d)  $G(s)H(s) = \frac{5K}{s(s+1)(s+2)}$

104. In a system, the damping coefficient is  $-2$ . The system response will be

- (a) Undamped
- (b) Oscillations with decreasing magnitude
- (c) Oscillations with increasing magnitude
- (d) Critically damped

105. A dynamic system is described by the following equations :

$$\dot{X} = \begin{bmatrix} 0 & 1 \\ -3 & -4 \end{bmatrix} X + \begin{bmatrix} 0 \\ 1 \end{bmatrix} u \text{ and}$$

$$Y = [10 \ 0] u$$

Then the transfer function relating Y and u is given by

- (a)  $\frac{Y(s)}{u(s)} = \frac{10s}{s^2 + 4s + 3}$
- (b)  $\frac{Y(s)}{u(s)} = \frac{10}{s^2 + 4s + 3}$
- (c)  $\frac{Y(s)}{u(s)} = \frac{s}{s^2 + 2s + 1}$
- (d)  $\frac{Y(s)}{u(s)} = \frac{s}{s^2 + 3s + 1}$

106. The characteristics of a mode of controller are summarized :

1. If error is zero, the output from the controller is zero.
2. If error is constant in time, the output from the controller is zero.
3. For changing error in time, the output from the controller is  $|K|\%$  for every  $1\% \text{ sec}^{-1}$  rate of change of error.
4. For positive rate of change of error, the output is also positive.

The mode of controller is

- (a) Integral controller
- (b) Derivative controller
- (c) Proportional derivative
- (d) Proportional integral

107. A 1000 V/400 V power transformer has a nominal short-circuit voltage  $V_{SC} = 40\%$ . Which one of the following statements is correct ?

- (a) A voltage of 400 V appears across the short-circuited secondary terminals.
- (b) A voltage of 16 V appears across the short-circuited secondary terminals.
- (c) When the secondary terminals are short-circuited, the rated current flows at the primary side at a primary voltage of 400 V.
- (d) The primary voltage drops to 400 V, when the secondary terminals are short-circuited.

108. Consider the following statements regarding three-phase transformers in Open-Delta (V-V) connections :

1. Being a temporary remedy when one transformer forms of Delta-Delta system is damaged, and removed from service.
2. The Volt Ampere (VA) supplied by each transformer is half of the total VA, and the system is not overloaded.
3. An important precaution is that load shall be reduced by  $\sqrt{3}$  times in this case.

Which of the above statements are correct ?

- (a) 1 and 2 only
- (b) 1 and 3 only
- (c) 2 and 3 only
- (d) 1, 2 and 3

109. On the Torque/Speed curve of an induction motor shown in the figure, four points of operation are marked as A, B, C and D.

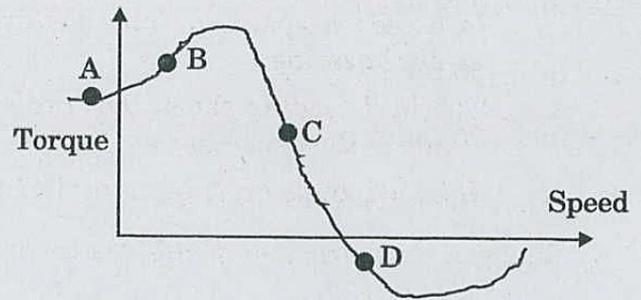

Which one of them represents the operation at a slip greater than 1 ?

- (a) A
- (b) B
- (c) C
- (d) D

110. A 3-phase, 460 V, 6-pole, 60 Hz cylindrical rotor synchronous motor has a synchronous reactance of  $2.5 \Omega$  and negligible armature resistance. The load torque, proportional to the square of the speed, is 398 N.m at 1200 rpm. Unity power factor is maintained by excitation control. Keeping the  $v/f$  constant, the frequency is reduced to 36 Hz. The torque angle  $\delta$  is

- (a)  $9.5^\circ$
- (b)  $12.5^\circ$
- (c)  $25.5^\circ$
- (d)  $30^\circ$

111. Consider the following statements regarding capability curves of a synchronous generator :

1. The MVA loading should not exceed the generator rating.
2. The field current should not be allowed to exceed a specified value determined by field heating.
3. The MW loading should not exceed the rating of the prime mover.
4. The load angle must be more than  $90^\circ$ .

Which of the above statements are correct ?

- (a) 1, 2, 3 and 4
- (b) 1 and 4 only
- (c) 1, 2 and 3 only
- (d) 2, 3 and 4 only

112. A 12-pole, 440 V, 50 Hz, 3-phase synchronous motor takes a line current of 100 A at 0.8 pf leading. Neglecting losses, the torque developed will be

- (a) 705 Nm
- (b) 1165 Nm
- (c) 1058 Nm
- (d) 525 Nm

113. Consider the following statements :

1. Salient pole alternators have small diameters and large axial lengths.
2. Cylindrical rotor alternators have a distributed winding.
3. Cylindrical rotor alternators are wound for large number of poles.
4. Salient pole alternators run at speeds slower than cylindrical rotor machines.

Which of the above statements are correct ?

- (a) 1 and 3 only
- (b) 2 and 4 only
- (c) 1 and 4 only
- (d) 2 and 3 only

114. A permanent magnet stepper motor with 8 poles in stator and 6 poles in rotor will have a step angle of

- (a)  $7.5^\circ$
- (b)  $15^\circ$
- (c)  $30^\circ$
- (d)  $60^\circ$

115. The transmission line is represented as a two-port network as shown in the figure. The sending end voltage and current are expressed in terms of receiving end voltage and current for the network as

$$V_S = A V_R + B I_R$$

$$I_S = C V_R + D I_R$$

where A, B, C and D are generalized circuit constants.

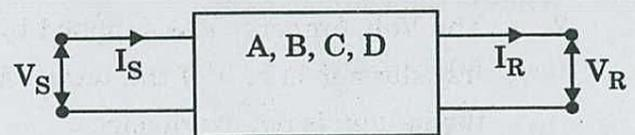

The condition for symmetry for the network is

- (a)  $A = C$
- (b)  $A = D$
- (c)  $B = C$
- (d)  $B = D$

116. A power system has two synchronous generators having governor turbine characteristics as

$$P_1 = 50(50 - f)$$

$$P_2 = 100(51 - f)$$

where  $f$  represents the system frequency. Assuming a lossless operation of the complete power system, what is the system frequency for a total load of 800 MW ?

- (a) 55.33 Hz  
 (b) 50 Hz  
 (c) 45.33 Hz  
 (d) 40 Hz
117. Two networks are connected in cascade in the figure. The equivalent ABCD constants are obtained for the combined network having  $C = 0.1 \angle 90^\circ$ .

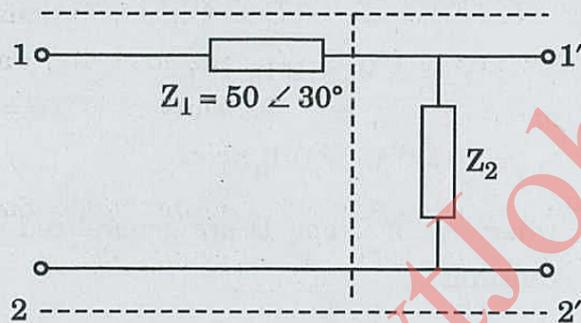

What is the value of  $Z_2$  ?

- (a)  $500 \angle -60^\circ$   
 (b)  $0.10j$   
 (c)  $-10j$   
 (d)  $50 \angle -60^\circ$
118. Which one of the following does *not* have an effect on corona ?
- (a) Spacing between conductors  
 (b) Conductor size  
 (c) Line voltage  
 (d) Length of conductor

119. Consider the following statements regarding corona :

1. It causes radio interference.
2. It attenuates lightning surges.
3. It causes power loss.
4. It is more prevalent in the middle conductor of a transmission line employing flat conductor configuration.

Which of the above statements are correct ?

- (a) 1, 2 and 3 only  
 (b) 1, 2 and 4 only  
 (c) 1, 2, 3 and 4  
 (d) 3 and 4 only

120. The loss formula coefficient matrix for a two-plant system is given by

$$B = \begin{bmatrix} 0.001 & -0.0001 \\ -0.0001 & 0.0013 \end{bmatrix} M\omega^{-1}$$

The economic schedule for a certain load is given as

$$P_1 = 150 \text{ MW and } P_2 = 275 \text{ MW.}$$

What is the penalty factor for plant 1 for this condition ?

- (a) 1.324  
 (b) 1.515  
 (c) 1.575  
 (d) 1.721

121. A lossless power system has two generators  $G_1$  and  $G_2$ ; and total load to be served is 200 MW. The respective cost curves  $C_1$  and  $C_2$  are defined as

$$C_1 = P_{G1} + 0.01 P_{G1}^2$$

$$C_2 = 5 P_{G2} + 0.02 P_{G2}^2$$

Assume the minimum loading on any generator to be 30 MW, the most economical loads  $P_{G1}$  and  $P_{G2}$  for the two generators are, respectively

- (a) 170 MW and 100 MW
- (b) 200 MW and 100 MW
- (c) 170 MW and 30 MW
- (d) 200 MW and 30 MW

122. In a 3-phase ac power transmission system using synchronous generation

- (a) The steady state power limits of both round rotor and salient pole machines are reached at  $\theta = \frac{\pi}{2}$  of their respective power angle characteristics.
- (b) The steady state power limit of round rotor machines occurs at a much smaller angle  $\theta$  as compared to that of salient pole machine power angle characteristic.
- (c) The steady state power limit of salient pole machines occurs at smaller angle  $\theta$  as compared to that of round rotor machine power angle characteristic.
- (d) The transient state power limits of synchronous generators do not depend on initial load just before the large change in load or on 3-phase fault.

123. Bulk power transmission over long HVDC lines is preferred because of

- (a) Low cost of HVDC terminal
- (b) No harmonic losses
- (c) Minimum line power losses
- (d) Simple protection

124. The turn-off time of a thyristor is 30  $\mu$ s at 50°C. What is its turn-off time at 100°C ?

- (a) 15  $\mu$ s
- (b) 30  $\mu$ s
- (c) 60  $\mu$ s
- (d) 120  $\mu$ s

125. The IGBT (Insulated Gate Bipolar Transistor) used in the circuit has the following data :  $t_{ON} = 3 \mu$ s,  $t_{OFF} = 1.2 \mu$ s, Duty cycle (D) = 0.7,  $V_{CE(sat)} = 2$  V and  $f_s = 1$  kHz.

What are the switching power losses during turn-on and turn-off, respectively ?

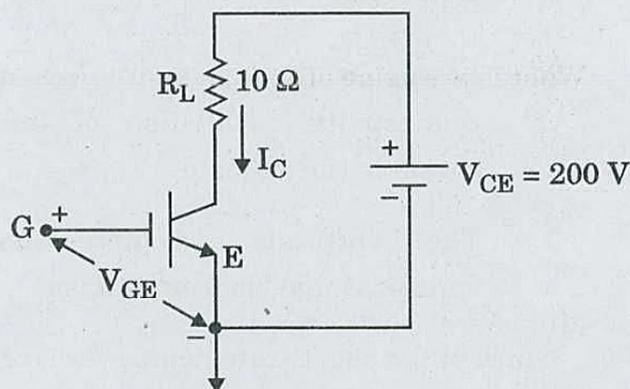

- (a) 1.98 W and 1.7 W
- (b) 2.2 W and 1.7 W
- (c) 1.98 W and 0.792 W
- (d) 2.2 W and 0.792 W

126. Consider the following statements with regard to a GTO :

1. The turn-off gain of the GTO is large.
2. Large negative gate current pulses are required to turn off the GTO.
3. GTO has large reverse blocking capability.

Which of the above statements is/are correct ?

- (a) 1 only
- (b) 2 only
- (c) 3 only
- (d) 1, 2 and 3

127. Consider the following statements with regard to power diodes :

1. The breakdown voltage is directly proportional to the doping density of the drift region.
2. Losses in the diode are less due to conductivity modulation of the drift region in the on-state.
3. The vertically oriented structure supports large blocking voltages.

Which of the above statements is/are correct ?

- (a) 1 only
- (b) 2 only
- (c) 3 only
- (d) 1, 2 and 3

128. A three-phase fully-controlled bridge converter is connected to a 415 V supply, having a source resistance of  $0.3 \Omega$  and inductance of  $1.2 \text{ mH}$  per phase. The converter is working in the inversion mode at a firing advance angle of  $30^\circ$ . What is the average generator voltage for the conditions : dc current  $I_d = 60 \text{ A}$ , thyristor drop =  $1.5 \text{ V}$  and  $f = 50 \text{ Hz}$  ?

- (a) 180 V
- (b) 210 V
- (c) 230 V
- (d) 240 V

129. A large dc motor is required to control the speed of the blower from a 3-phase ac source. The suitable ac to dc converter is, 3-phase

- (a) Fully controlled bridge converter
- (b) Fully controlled bridge converter with freewheeling diode
- (c) Half controlled bridge converter
- (d) Converter pair in sequence control

130. Consider the following statements :

1. The voltage developed across the OFF switches of the half bridge converter is the maximum dc link voltage.
2. In the full bridge converter, the voltage across the primary of the transformer is the dc link voltage.
3. The voltage developed across the OFF switches of the full bridge converter is half the maximum dc link voltage.

Which of the above statements are correct ?

- (a) 1, 2 and 3
- (b) 1 and 3 only
- (c) 1 and 2 only
- (d) 2 and 3 only

**Directions :** Each of the next **twenty (20)** items consists of two statements, one labelled as 'Statement (I)' and the other as 'Statement (II)'. Examine these two statements carefully and select the answers to these items using the codes given below :

**Codes :**

- (a) Both Statement (I) and Statement (II) are individually true and Statement (II) is the correct explanation of Statement (I)
- (b) Both Statement (I) and Statement (II) are individually true but Statement (II) is **not** the correct explanation of Statement (I)
- (c) Statement (I) is true but Statement (II) is false
- (d) Statement (I) is false but Statement (II) is true

**131. Statement (I) :**

A superconductor is a perfect diamagnetic material.

**Statement (II) :**

A superconductor is a perfect conductor.

**132. Statement (I) :**

Limiting factor of DC transmission is the high cost of conversion equipment.

**Statement (II) :**

Generation of harmonics is used for reactive power transfer only which has the ability to alter voltage levels.

**133. Statement (I) :**

A lattice defect gets created whenever the periodicity or order of the crystal lattice gets disturbed.

**Statement (II) :**

Point defect, line defect, surface defect and volume defect create defect in lattice.

**134. Statement (I) :**

To measure power consumed by the load, it is necessary to interchange the pressure coil terminals when the pointer of a wattmeter kicks back.

**Statement (II) :**

The pressure coil terminals are interchanged to get upscale reading in a wattmeter without affecting the continuity of power to the load.

**135. Statement (I) :**

An instrument manufactured as an ammeter should not be used as a voltmeter.

**Statement (II) :**

The high resistance winding of an ammeter will suffer serious damage if connected across a high voltage source.

**136. Statement (I) :**

Moving iron instruments are used in ac circuits only.

**Statement (II) :**

The deflecting torque in moving iron instruments depends on the square of the current.

**137. Statement (I) :**

PMMC instruments are suitable in aircraft and air space applications.

**Statement (II) :**

PMMC instruments use a core magnet which possesses self-shielding property.

**138. Statement (I) :**

A ballistic galvanometer is preferred as a detector in an AC bridge to measure inductance supplied by a source at power frequency.

**Statement (II) :**

An AC bridge to measure inductance is balanced at the fundamental component.

139. *Statement (I) :*

Phase lag network is used to increase stability as well as bandwidth of the system.

*Statement (II) :*

Phase lead network increases bandwidth of the system.

140. *Statement (I) :*

The inductor is not used to fabricate a lag network as it produces time delay and hysteresis loss.

*Statement (II) :*

A capacitor cannot be used to fabricate a lag network.

141. *Statement (I) :*

Roots of closed-loop control systems can be obtained from the Bode plot.

*Statement (II) :*

Nyquist criterion does not give direct value of corner frequencies.

142. *Statement (I) :*

The IGBT makes use of the advantages of both powers MOSFET and BJT.

*Statement (II) :*

The IGBT has MOS input characteristic and bipolar output characteristic.

143. *Statement (I) :*

The power distribution systems are 3-phase 4-wire circuits.

*Statement (II) :*

A neutral wire is necessary to supply single-phase loads of domestic and marginal commercial consumers.

144. *Statement (I) :*

The maximum torque of an induction motor is independent of rotor resistance.

*Statement (II) :*

The slip at which the maximum torque occurs is directly proportional to rotor resistance.

145. *Statement (I) :*

A 3-phase induction motor is a self-starting machine.

*Statement (II) :*

A star-delta starter is used to produce starting torque for the induction motor.

146. *Statement (I) :*

Leakage reactance of the lower cage in a double-squirrel-cage motor is considerably higher than that of the upper cage.

*Statement (II) :*

The lower cage has high permeance for leakage flux.

147. *Statement (I) :*

Superconducting compounds and alloys must have components which are themselves superconducting.

*Statement (II) :*

Metals and compounds which are superconducting are rather bad conductors at ordinary temperatures.

148. *Statement (I) :*

The relative dielectric constant of an insulator decreases with increase in the frequency of the applied alternating field.

*Statement (II) :*

With increase in frequency of the applied field, polarization process increases.

149. *Statement (I) :*

One series RC circuit and the other series RL circuit are connected in parallel across an ac supply. The circuit exhibits two resonances when L is variable.

*Statement (II) :*

The circuit has two values of L for which the imaginary part of the input admittance of the circuit is zero.

150. *Statement (I) :*

The power available from wind is directly proportional to  $V^3$ , where V is the velocity.

*Statement (II) :*

Drag type wind turbines have lower speeds and high torque capabilities.

**SPACE FOR ROUGH WORK**

GovtJobsAlert.In

**SPACE FOR ROUGH WORK**

GovtJobsAlert.In

**SPACE FOR ROUGH WORK**

GovtJobsAlert.In

**SPACE FOR ROUGH WORK**

GovtJobsAlert.In